

# Characterizing Digitally Modulated Signals with CCDF Curves

Application Note

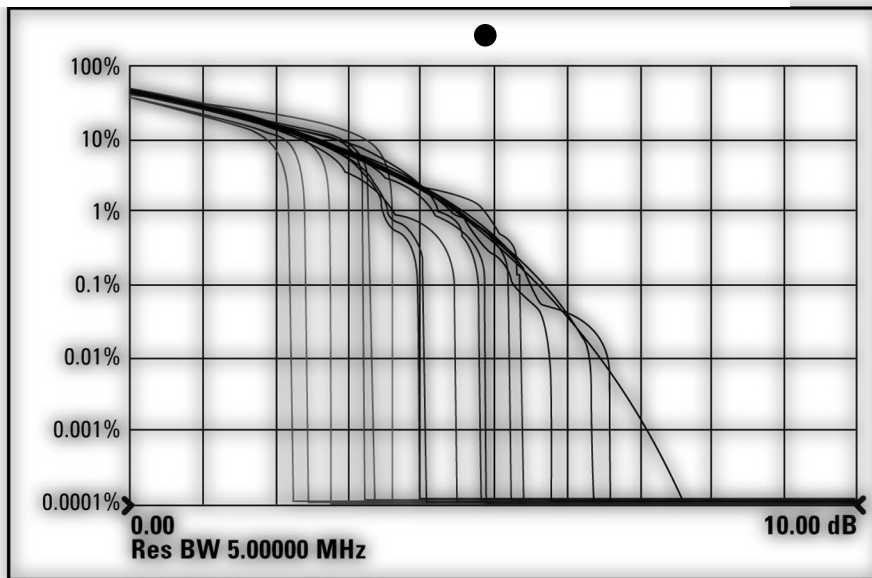
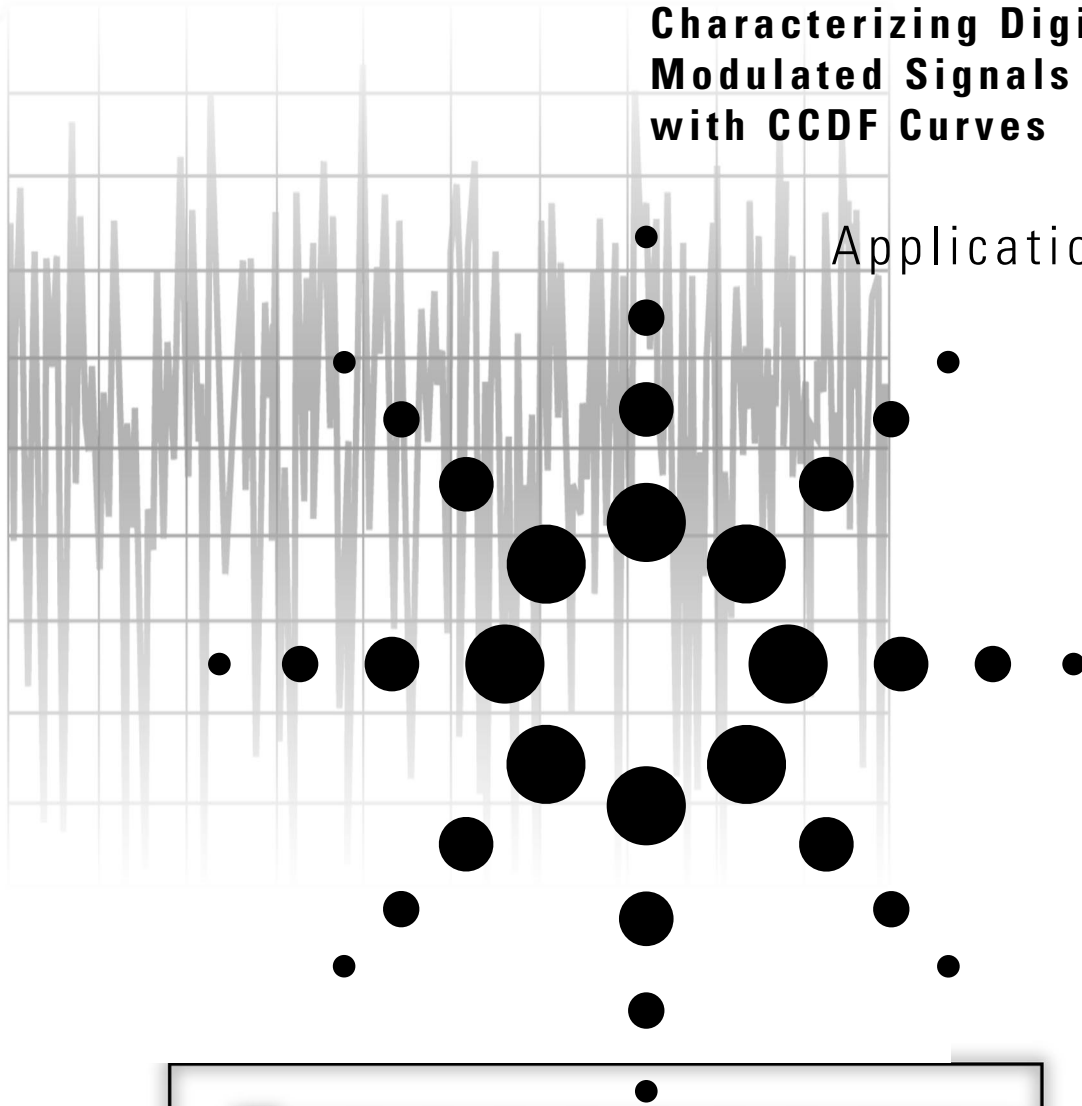

# Table of Contents

## **1. Introduction**

When are CCDF curves used?

## **2. What are CCDF curves?**

Statistical origin of CCDF curves

Why not crest factor?

## **3. CCDF in communications**

Modulation formats

Modulation filtering

Multiple-frequency signals

Phases affect multi-tone signals

Spread-spectrum systems

Number of active codes in spread spectrum

Orthogonal coding effects

Multi-carrier signals

## **4. CCDF in component design**

Compression of signal by nonlinear components

Correlating the amplifier curves with the CCDF plot

Compression affects other key measurements

Applications

## **5. Summary**

## **6. References**

## **7. Symbols and acronyms**

# Introduction

Digital modulation has created a revolution in RF and microwave communications. Cellular systems have moved from the old analog AMPS and TACS systems to second generation NADC, CDMA, and GSM standards. Today, the cellular industry talks of moving to third generation (3G) digital systems such as W-CDMA and cdma2000. Outside of cellular communications, the broadcast industry is also moving into the era of digital modulation. High Definition Television (HDTV) systems will use 8-level Vestigial Side Band (8VSB) and Coded Orthogonal Frequency Division Multiplexing (COFDM) digital modulation formats in various parts of the world.

The move to 3G systems will yield signals with higher peak-to-average power ratios (crest factors) than previously encountered. Analog FM systems operate at a fixed power level: analog double-sideband large-carrier (DSB-LC) AM systems cannot modulate over 100% (a peak value 6 dB above the unmodulated carrier) without distortion. Third generation systems, on the other hand, combine multiple channels, resulting in a peak-to-average ratio that is dependent upon not only the number of channels being combined, but also which specific channels are used. This signal characteristic can lead to higher distortion unless the peak power levels are accounted for in the design of system components, such as amplifiers and mixers.

Power Complementary Cumulative Distribution Function (CCDF) curves provide critical information about the signals encountered in 3G systems. These curves also provide the peak-to-average power data needed by component designers.

This application note examines the main factors that affect power CCDF curves, and describes how CCDF curves are used to help design systems and components.

When are CCDF curves used? Perhaps the most important application of power CCDF curves is to specify completely and without ambiguity the power characteristics of the signals that will be mixed, amplified, and decoded in communication systems. For example, baseband DSP signal designers can completely specify the power characteristics of signals to the RF designers by using CCDF curves. This helps avoid costly errors at system integration time. Similarly, system manufacturers can avoid ambiguity by completely specifying the test signal parameters to their amplifier suppliers.

CCDF curves apply to many design applications. Some of these applications are:

- Visualizing the effects of modulation formats.
- Combining multiple signals via systems components (for example, amplifiers).
- Evaluating spread-spectrum systems.
- Designing and testing RF components.

# What are CCDF curves?

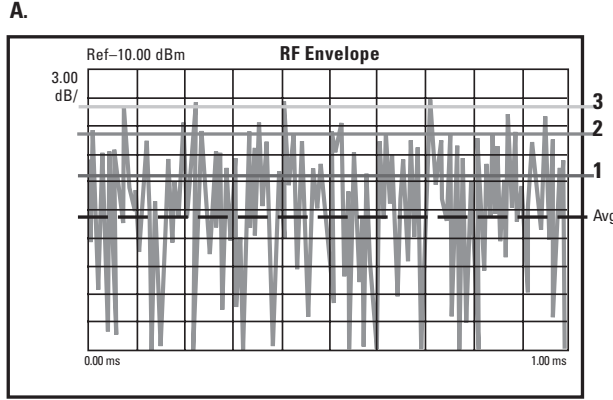

Figure 1A: Construction of a CCDF curve

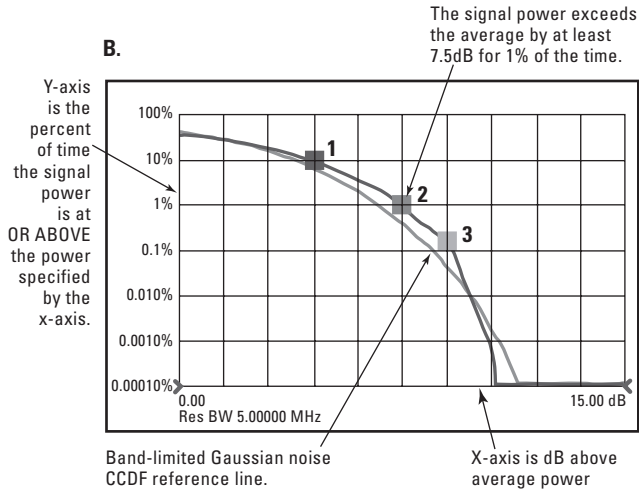

Figure 1B: CCDF curve of a typical cdmaOne signal

A CCDF curve shows how much time the signal spends at or above a given power level. The power level is expressed in dB relative to the average power. For example, each of the lines across the waveform shown in *Figure 1A* represents a specific power level above the average. The percentage of time the signal spends at or above each line defines the probability for that particular power level. A CCDF curve is a plot of relative power levels versus probability.

*Figure 1B* displays the CCDF curve of the same 9-channel cdmaOne signal captured on the E4406A VSA. Here, the x-axis is scaled to dB above the average signal power, which means we are actually measuring the peak-to-average ratios as opposed to absolute power levels. The y-axis is the percent of time the signal spends at or above the power level specified by the x-axis. For example, at  $t = 1\%$  on the y-axis, the corresponding peak-to-average ratio is 7.5 dB on the x-axis. This means the signal power exceeds the average by at least 7.5 dB for 1 percent of the time. The position of the CCDF curve indicates the degree of peak-to-average deviation, with more stressful signals further to the right.

*Figure 1A* shows the power versus time plot of a 9-channel cdmaOne signal. This plot represents the instantaneous envelope power defined by the equation:

$$\text{Power} = I^2 + Q^2$$

where  $I$  and  $Q$  are the in-phase and quadrature components of the waveform.

Unfortunately, the signal in the form shown in *Figure 1A* is difficult to quantify because of its inherent randomness and inconsistencies. In order to extract useful information from this noise-like signal, we need a statistical description of the power levels in this signal, and a CCDF curve gives just that.

# Statistical origin of CCDF curves

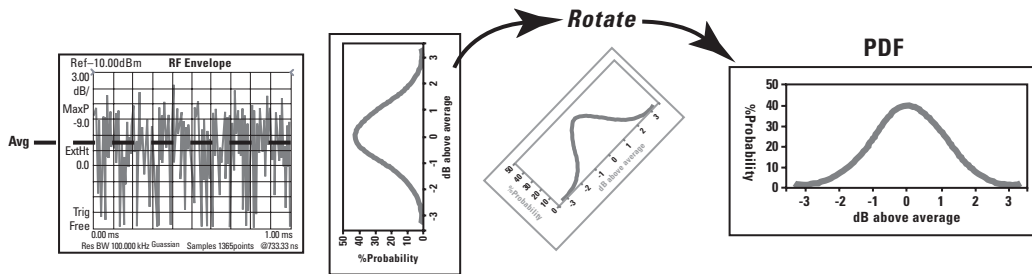

Now that we've seen a practical CCDF curve (Figure 1A), let's briefly investigate the mathematics of CCDF curves. Let's start with a set of data that has the Probability Density Function (PDF) shown in Figure 2. To obtain the Cumulative Distribution Function (CDF), we compute the integral of the PDF. Finally, inverting the CDF results in the CCDF. That is, the CCDF is the complement of the CDF (CCDF = 1 - CDF). To generate the CCDF curve in the form shown in Figure 1A, convert the y-axis to logarithmic form and begin the x-axis at 0 dB. A logarithmic y-axis provides better resolution for low-probability events. The reason we plot CCDF instead of CDF is that CCDF emphasizes peak amplitude excursions, while CDF emphasizes minimum values.

## Why not crest factor?

As the need for characterizing noise-like signals becomes greater, we search for the most convenient, useful, and reliable measurement to meet this need. Traditionally, a common measure of stress for a stimulating signal has been the crest factor. Crest factor is the ratio of the peak voltage to its root-mean-square value.

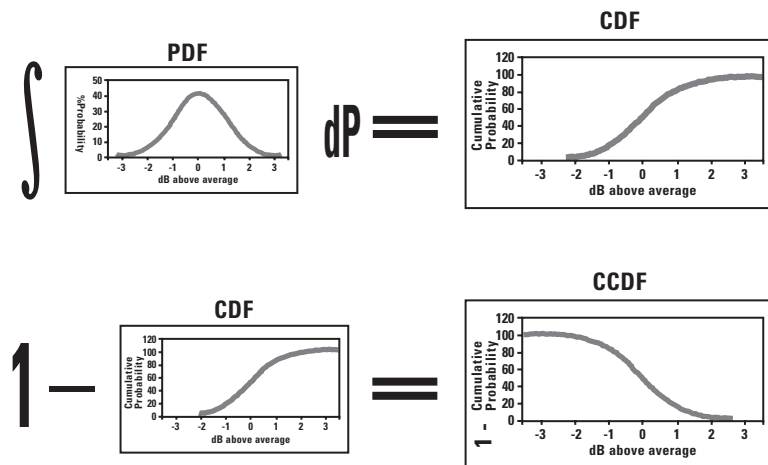

Figure 2: Mathematical origin of CCDF

This measurement is of questionable value for several reasons:

- Error-correction coding will often remove the effect of a single error-causing peak in the system.
- A single peak that is much higher than the prevailing signal level sometimes is treated as an anomalous condition and ignored.
- A peak that occurs infrequently causes little spectral regrowth, which makes repeatable measurements difficult.
- The highest peak value that occurs for true noise depends on the length of the measurement time.

In short, crest factor places too much emphasis on a signal's instantaneous peak value. To mitigate this, the peak value is sometimes considered to be the level where 99.8 percent of the waveform is below the peak value, and 0.2 percent of the waveform is above it. While this lessens the emphasis on a single point of a waveform, the use of a single level (such as 0.2 percent) is still rather arbitrary. CCDF gives us more complete information about the high signal levels than does crest factor [1].

# CCDF in communications

## A. QPSK signal

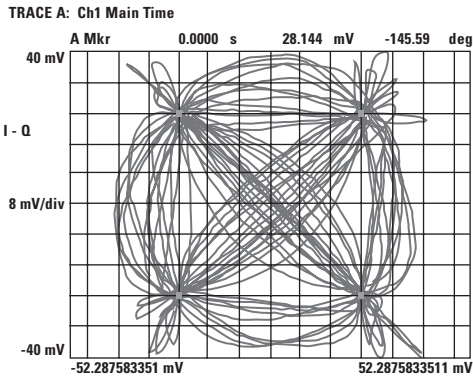

## B. 16QAM signal

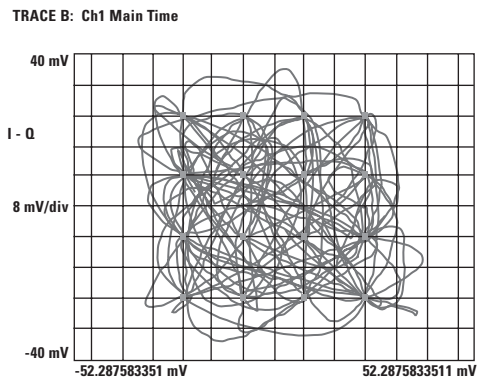

Figure 3: Vector plots of (A.) QPSK signal and (B.) 16QAM signal

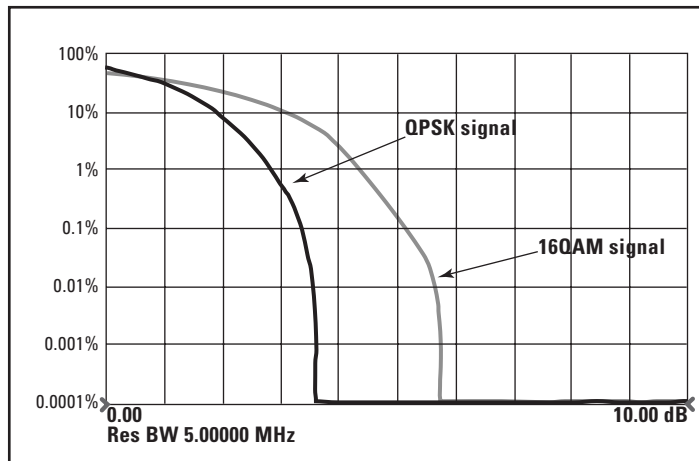

Figure 4: CCDF curves of a QPSK signal and a 16QAM signal

### Modulation formats

The modulation format of a signal affects its power characteristics. Using CCDF curves, we can fully characterize the power statistics of different modulation formats, and compare the results of choosing one modulation format over another.

In *Figure 3*, the vector plot of a Quadrature Phase Shift Keying (QPSK) signal is compared to that

of a 16-Quadrature Amplitude Modulation (16QAM) signal. A QPSK signal transfers only two bits per symbol, while a 16QAM signal transfers four bits per symbol. Therefore, the bit rate of a 16QAM signal is twice that of a QPSK signal for a given symbol rate. The 16QAM signal appears to have higher peak-to-average power ratios, but it is difficult to make quantitative observations from this plot.

*Figure 4* shows the power CCDF curves of both a 16QAM and QPSK signal obtained by the HP E4406A VSA. We can quickly verify that the 16QAM signal has a more stressful CCDF curve than that of the QPSK signal. While 16QAM is capable of transmitting more bits per state than QPSK for a given symbol rate, it also produces greater peak-to-average ratios than does QPSK.

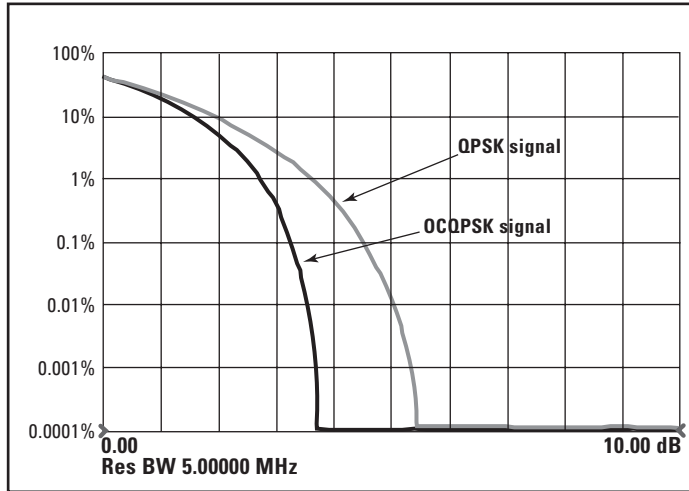
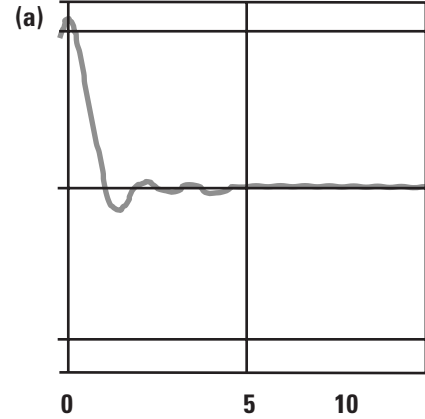

Figure 5: CCDF curves of a QPSK signal and a OCQPSK signal.

This implies that the amplifiers and components used for a 16QAM signal will have different design needs than those for QPSK signals because of the higher peak-to-average statistics.

Similarly, we can use CCDF curves to compare between QPSK and Orthogonal Complex QPSK (OCQPSK). The CCDF curves in *Figure 5* immediately tell us that OCQPSK is less stressful than QPSK. This is one of the reasons why 3G cellular systems will use OCQPSK in the mobile stations.

### High-alpha root-raised-cosine filter



### Low-alpha root-raised-cosine filter

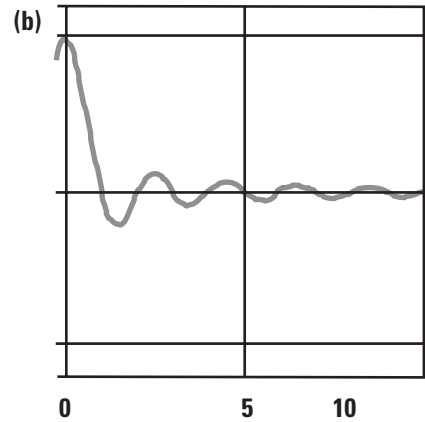

Figure 6: Impulse response of a high-alpha and a low-alpha filter.

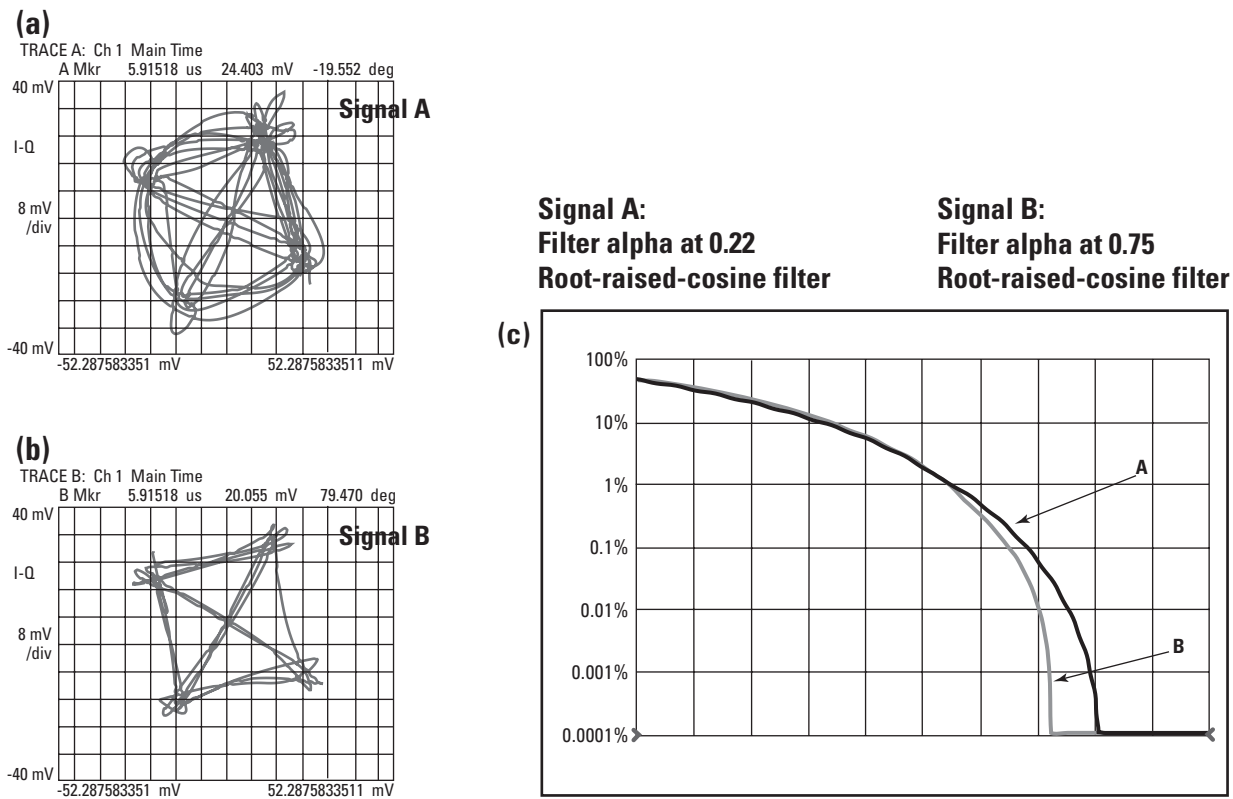

Figure 7: CCDF curve and vector plots of high-alpha filter and low-alpha filter.

### Modulation filtering

The filtering parameters for a particular modulation format can significantly affect the CCDF curves of the signal. Although low-alpha (low- $\alpha$ ) filters require less bandwidth than high-alpha filters, they have a longer response time and more severe ringing (*Figure 6*). This time-domain ringing results in the addition of more symbols, which causes higher peak-power events.

For example, *Figure 7c* shows the CCDF plots of QPSK signals with different filtering  $\alpha$  factors, captured on an E4406A VSA. Also shown (*Figures 7a* and *7b*) are the vector diagrams of the two signals. The magnitude of the

time-trace vector plot squared would represent the power of the signals. Signal A clearly looks more spread out in the vector plot due to the lower filter alpha. The CCDF plot confirms that the low- $\alpha$  filter produces higher peak-power events than the high- $\alpha$  filter. However, as mentioned above, high- $\alpha$  filters also require a larger bandwidth.

The CCDF curve can be used to troubleshoot signals. Higher or lower CCDF curves give an indication of the filtering present on the signal. An incorrect curve could identify incorrectly coded baseband signals.



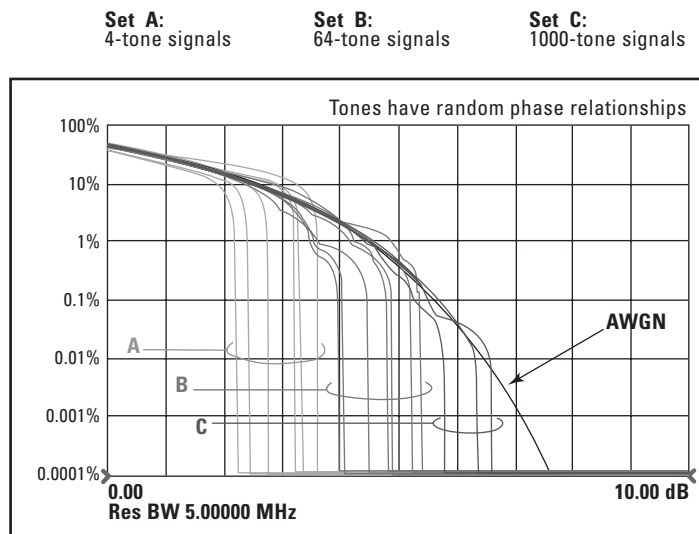

Figure 8: CCDF curves of multiple frequency signals.

### Multiple-frequency signals

Combining multiple signals of different frequencies increases the power in the resulting multi-tone signal, creating problems for the overall system.

A single Continuous Wave (CW) signal has a substantially constant envelope power, which means that its peak envelope power nearly equals its average power. Theoretically, the CCDF curve of this signal should be a point at 0 dB and 100%. On the other hand, two CW signals at different frequencies create a time-domain

waveform with fluctuating amplitude, similar to an AM signal. The CCDF curve of a two-CW signal differs significantly from that of the single CW signal.

Figure 8 shows the sets of CCDF curves of 4-CW, 64-CW, and 1000-CW signals displayed on the E4406A VSA. These tones all have random phase relationships, which is why the number of tones is somewhat ambiguous when specifying the power characteristics of multi-tone signals (see specifying the power characteristics of multi-tone signals, below). However, as the number of tones increases, we expect the peak-power events to also increase.

The same effect applies to multiple digitally modulated signals at different frequencies sent through a single amplifier or antenna. Many of today's schemes to achieve multi-carrier signals must consider such effects. For instance, an amplifier designed for a GSM signal only transmits a constant envelope signal during a time slot. However, an amplifier designed for multiple GSM signals at different frequencies will need to handle signals with significantly more stressful CCDF curve power statistics.

Looking at Figure 8 again, notice that as the number of tones increases, the CCDF curves begin to resemble the Additive White Gaussian Noise (AWGN) curve. This becomes an important application in Noise Power Ratio (NPR) measurements.

NPR is a common characterization for nonlinear performance in communications circuits. The NPR test requires a Gaussian noise stimulus with a notch located in the center of the band. The stimulus is generated using large filters and components. An alternative NPR test stimulus, which can reduce costs and maximize workspace, is an arbitrary waveform signal generator capable of generating a multi-tone CW signal. To simulate a notch in the multi-tone signal, tones are omitted at the frequencies where the notch is desired. As we saw in Figure 10, one of the 1000-tone signals (the one in the middle) closely approximates the AWGN up to about 9.5 dB. The CCDF curve allows us to easily determine how closely the multi-tone signal matches a true AWGN signal.

**Phases affect multi-tone signals**

As mentioned in the previous section, the phase relationships of multi-tone signals can either significantly reduce or increase the power statistics. We saw above that a signal with more tones is likely to have more stressful power characteristics. However,

it is possible to generate a signal with fewer tones that is as stressful or sometimes more stressful than a signal with more tones. For instance, *Figure 9* shows that a 4-tone signal with all phases aligned is slightly more stressful than one particular 64-tone signal with random phase relationships.

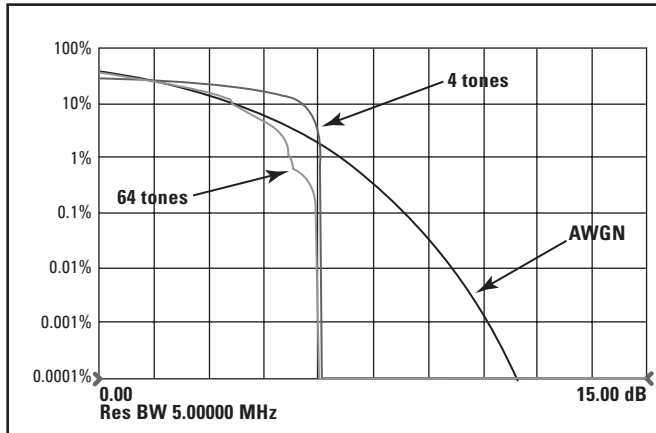

Figure 9: CCDF curves for a phase-aligned 4-tone signal and a 64-tone signal with random phases.

A multi-tone signal in which the phases of all tones are aligned yields the maximum CCDF curve possible. *Figure 10* shows two spectrally identical 8-tone signals. Signal A has initial phases aligned at 0 degrees, while Signal B has phases offset by 45 degrees (that is, 0, 45, 90, ... , 315 degrees). The aligned phase signal (Signal A) has a significantly more stressful CCDF curve.

- Signal A:**  
8 tones have phases all aligned
- Signal B:**  
8-tones have phases offset by 45 degrees

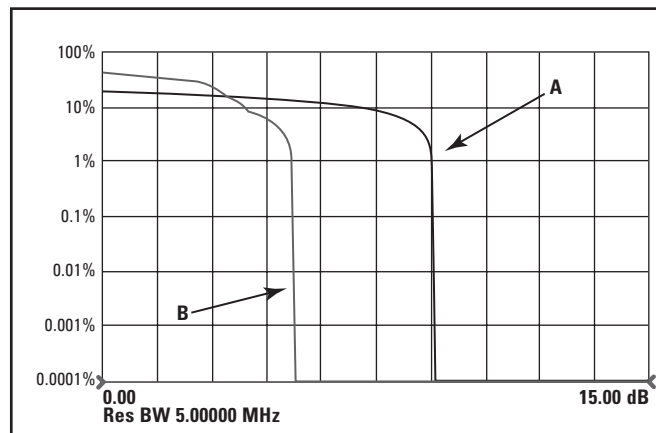
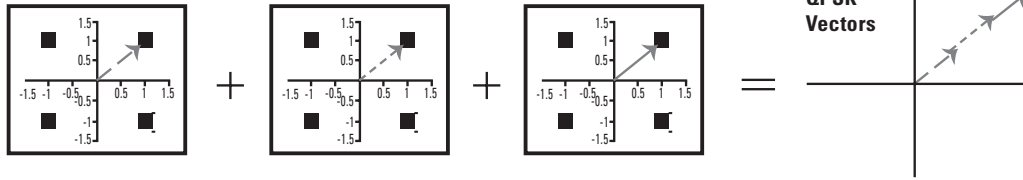

Figure 10: CCDF curves of 8-tone signals

### A. QPSK



### B. QPSK

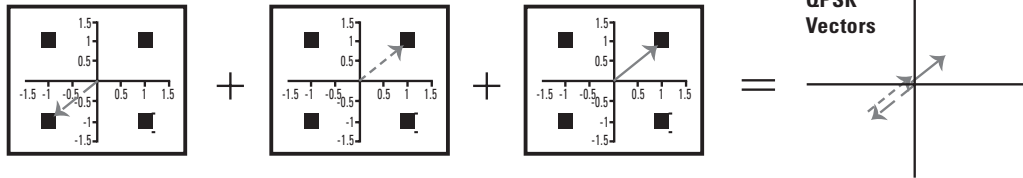

Figure 11: (A) Addition and (B) cancellation of vectors in spread-spectrum systems.

### Spread-spectrum systems

We can view spread-spectrum signals as multiple QPSK signals summed together at baseband. Each QPSK signal represents a unique user channel or information stream. Since these user channels are all transmitted together in the same frequency band, the system relies on orthogonal coding in order to separate the information for different users.

Orthogonal codes allow spreading of the information bits from each user. IS-95 cdmaOne format uses Walsh codes. A "1" information bit sends all 64 bits of the appropriate Walsh code. A "0" information bit sends the inverse 64 bits of the appropriate Walsh code. Next, the Walsh-coded information translates into a QPSK vector. (cdmaOne spread-spectrum

systems send each bit to both I and Q, while 3G systems send every other bit to I or Q.) The vectors associated with all the active codes then superimpose upon one another to form a spread-spectrum signal. Finally, at the receiver end, most systems apply a known scrambling code in order to distinguish and to retrieve the desired user information.

Adding up the QPSK vectors of multiple codes defines the peak power for a symbol at any given time. As displayed in *Figure 11*, the vectors sometimes add up (when in the same direction), and sometimes cancel each other out (when in opposing directions). With the presence of more codes, the potential peak power of the signal rises. The CCDF curve of a signal reflects this fact.

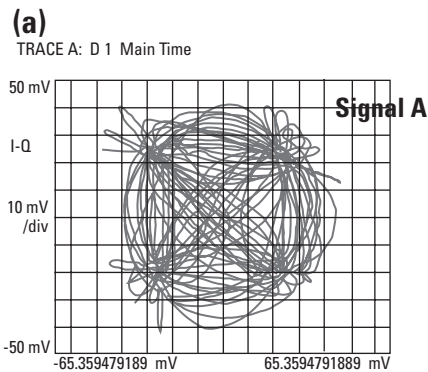

**Signal A:**  
cdmaOne signal-Pilot

**Signal B:**  
cdmaOne signal-Pilot plus eight other channels

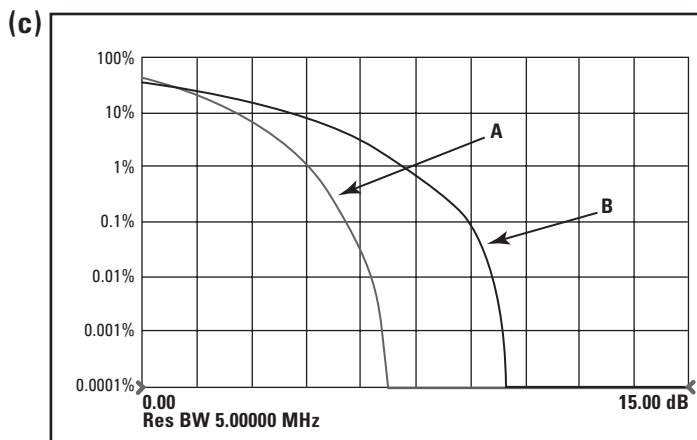
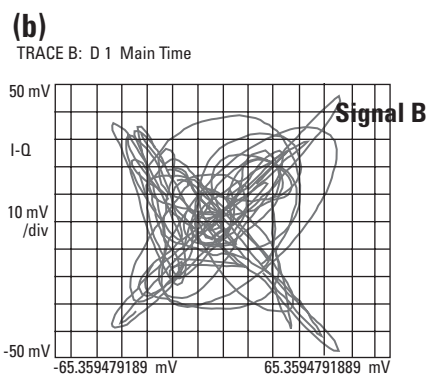

Figure 12: CCDF curves and vector plots of a single-channel cdmaOne signal and a nine-channel cdmaOne signal.

**Number of active codes in spread spectrum**

The number of active codes in a spread-spectrum system affects the power statistics of the signal. Increasing the number of channels in a spread-spectrum system increases the power peaks, thus incurring higher stress on system components.

In *Figure 12c*, we compare the CCDF curves of two cdmaOne signals. Signal A (pilot channel) has a significantly lower statistical power ratio than does Signal B (pilot plus 8 other randomly chosen channels) as indicated by the CCDF curves and the vector plots. As expected, the signal with higher channel usage has a more stressful power CCDF curve.

**Signal A (9 cdmaOne codes):**  
 Pilot: code 0  
 Sync: code 32  
 Paging: code 1  
 Traffic: codes 8, 9, 10, 11, 12, 13

**Signal B (9 worst spacing codes):**  
 Pilot: code 0  
 Sync: code 32  
 Paging: code 7  
 Traffic: codes 15, 22, 39, 47, 55, 63

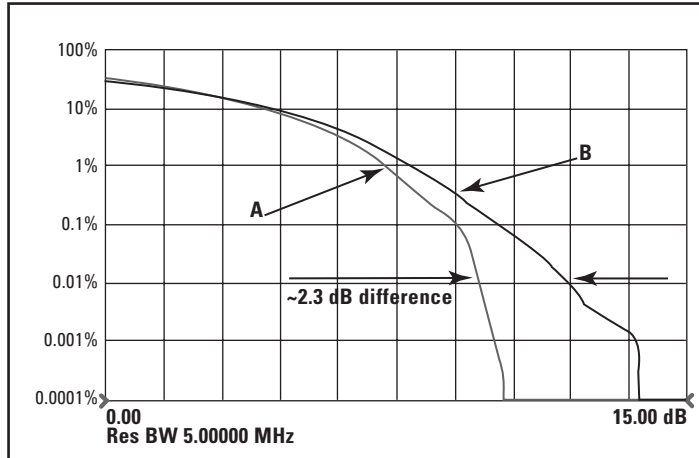

Figure 13: Effect of code selection on CCDF curves.

### Orthogonal coding effects

Given a fixed number of active CDMA code channels, the peak-to-average power ratios of a signal depend on the specific selection of the channels used. This is a consequence of orthogonal coding effects. The deterministic construction process for Walsh codes gives the codes some symmetric properties. The symmetric properties are the main reason that certain code combinations have more stressful CCDF curves than others. These code combinations are also deterministic.

In *Figure 13*, we compare the CCDF curves of two cdmaOne signals. Signal A and Signal B each have nine active codes. However, Signal A consists of randomly chosen codes, while Signal B consists of one of the worst (most stressful) 9-code combinations possible. There is a significant difference between the CCDF curves of the two signals.

**Signal A (9 cdmaOne codes):**  
Output signal of amplifier passes ACPR test.

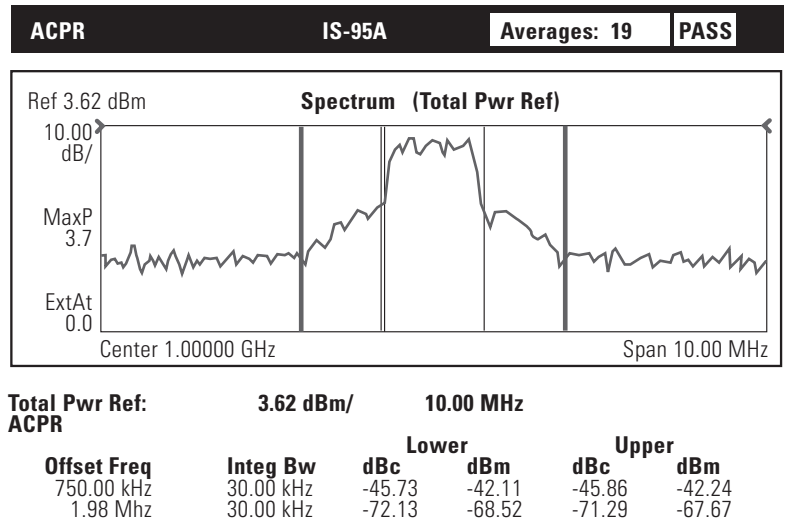

Suppose an amplifier designer was asked to design an amplifier with certain ACPR characteristics for a 9-channel CDMA signal. If the CCDF curve of the signal was not defined, the amplifier designer would encounter ambiguity in the design specifications. The designer could design the amplifier to work with Signal A, but the customer might test the amplifier with Signal B and fail the amplifier (Figure 14). From the CCDF curve, the designer would have to design the amplifier with about 2.3 dB more range for Signal B. CCDF curves can help amplifier designers avoid ambiguity in design specifications.

**Signal B (9 worst spacing codes):**  
Output signal of amplifier fails ACPR test

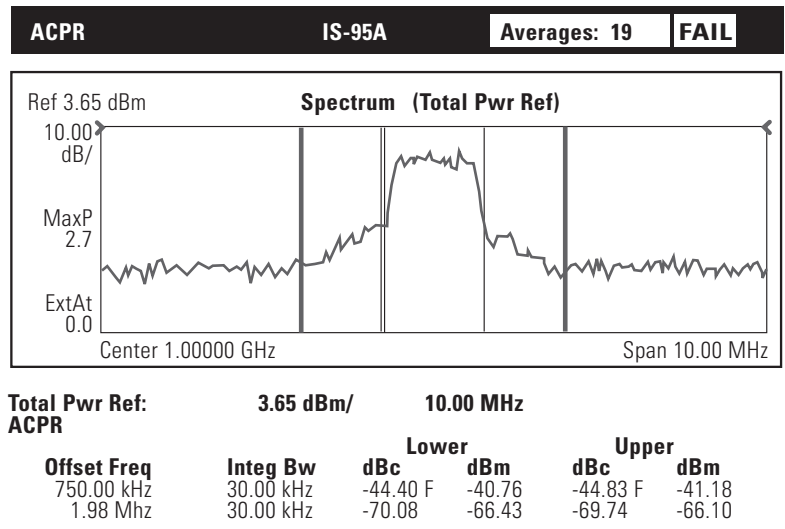

Figure 14: ACPR measurements of amplified signals.

**Signal A:**

One 9-active-code cdmaOne signal

**Signal B:**

Three 9-active-code cdmaOne signals

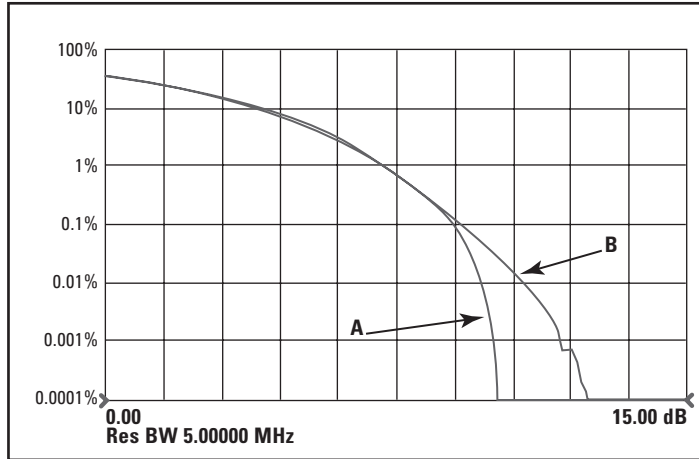

Figure 15: CCDF curves for a multi-carrier cdmaOne signal and a single-carrier cdmaOne signal

**Multi-carrier signals**

As discussed earlier, multi-tone signals cause greater stress on components such as amplifiers and mixers than single-tone signals. This effect also applies to multi-carrier signals in spread-spectrum systems, since multi-carrier signals use distinct frequency bands. Many companies are now creating amplifier designs that can handle combined multi-carrier cdmaOne signals.

Figure 15 compares the CCDF curve of a 9-code cdmaOne signal to that of three 9-code cdmaOne signals combined (in adjacent frequency channels), measured with the E4406A VSA. Clearly, the multi-carrier signal B has the more stressful CCDF curve. Using CCDF curves, power amplifier designers know exactly how stressful a signal the amplifier will need to handle. Systems developers also need to consider this power increase to ensure proper operation of the system.

## CCDF in component design

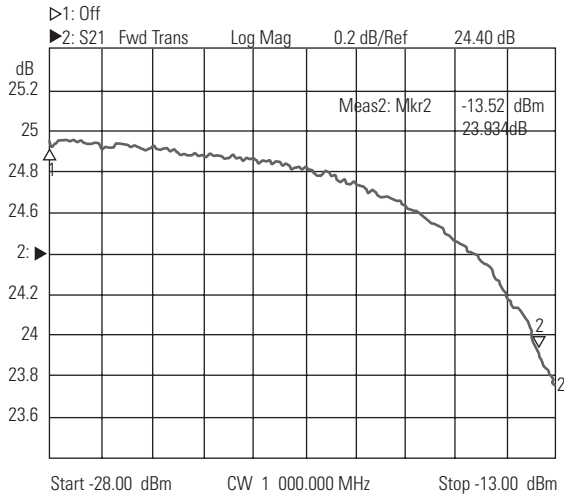

(a) Gain versus input power

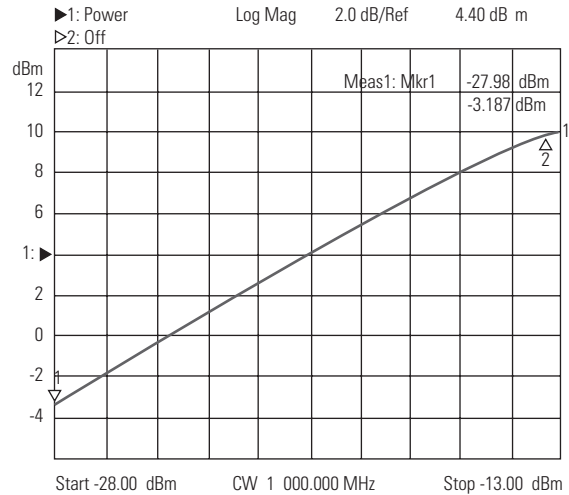

(b) Output power versus input power

Figure 16: Characterization of power amplifier

### Compression of signal by nonlinear components

In nonlinear components, compression of signals may occur. For instance, an amplifier compresses a signal when the signal exceeds the amplifier power limitations. To avoid compression, an engineer needs to know the [optimum] input power level for the amplifier. We will see how CCDF curves can be used to determine input power levels and serve as a guide for RF power amplifier designers and systems engineers.

Figure 16 shows two characterizations of the same amplifier. The left display shows the amplifier gain versus input power. The right display shows the same information portrayed as a plot of output power versus input power. Consider a noise-like signal passing through this amplifier. If both the input and output signals remain within the power constraints of the amplifier, then the output would be a linear amplification of the input signal. However, if either the input or output signal exceeds the power limitations of the amplifier, the signal undergoes compression.



**(a) Amplifier input signal**

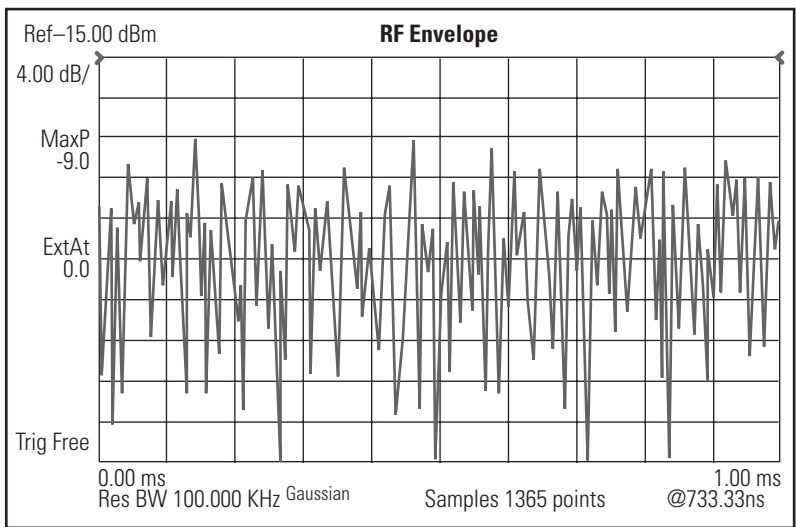

Unfortunately, it is difficult to see compression effects in the time domain (*Figure 17*), because we cannot see appreciable amounts of clipping. Even if we were able to perceive some clipping, we have no convenient way of describing the compression quantitatively in the time domain. However, we can easily detect compression of a signal by comparing the power CCDF curves of the input signal and the amplified output signal.

**(b) Output power versus input power**

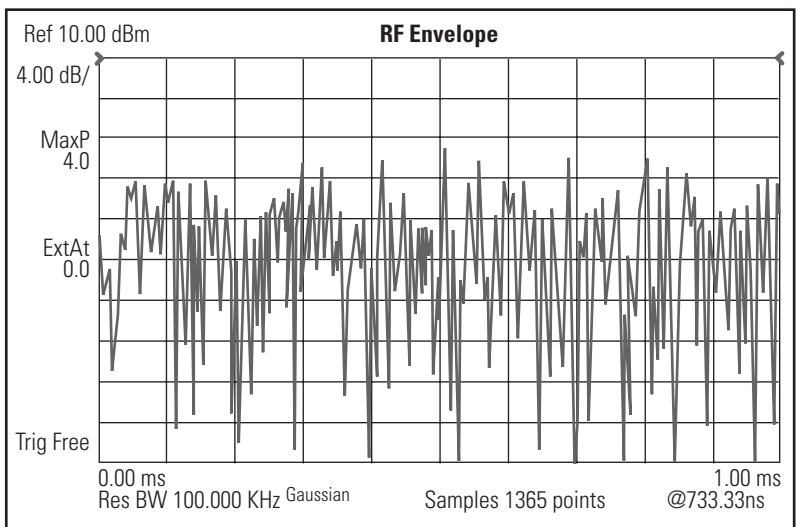

Figure 17: Power-versus-time plots for input and output signals of an amplifier.

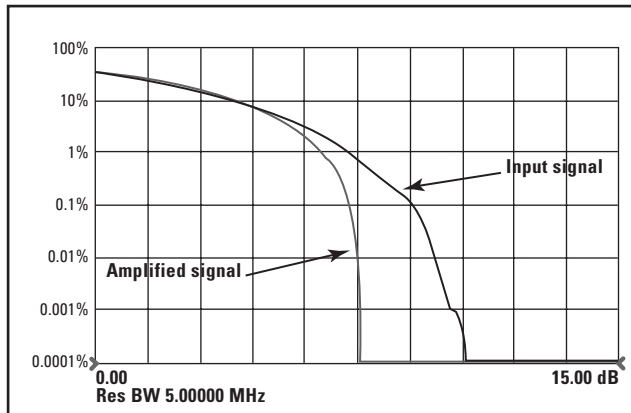

Figure 18: Compression effects displayed by CCDF curves.

As seen in *Figure 18*, CCDF curves are clearly an excellent tool for displaying compression effects. By definition, CCDF curves measure how far and how often a signal exceeds the average power. If a signal passing through an amplifier were perfectly (linearly) amplified, the output waveform of the signal in the time domain would perfectly resemble the input waveform, with a gain in power. Both the average and envelope power of the amplified signal would increase by a common factor. Therefore, the peak-to-average power ratio would not change, and the two CCDF curves would appear identical. However, when the output signal exceeds the power limitations of the amplifier, clipping occurs; the output waveform no longer resembles an amplified version of the input waveform, and the peak-to-average ratios change. The CCDF curve of the clipped signal decreases and no longer matches the original input signal. This effect makes the CCDF a good indicator of compression.

### Correlating the amplifier curves with the CCDF plot

*Figure 19* correlates the input signal CCDF curve to the amplifier gain versus input power plot. The power axes of the CCDF curve and the gain curve have the same scale, allowing us to line up the two curves. We have shifted the graph to line up the 0 dB point of the CCDF curve with the average power of the input signal on the gain curve. Now, we can correlate the two graphs.

For example, the input signal spends 3% of its time at or above 6 dB relative to the average power (from the CCDF curve). Since the average power of the signal equals  $-21$  dBm, peaks will occur above  $-15$  dBm 3% of the time. At  $-15$  dBm on the gain curve, the signal is compressed about 0.6 dB. Therefore, the signal

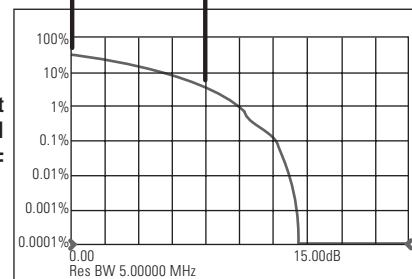
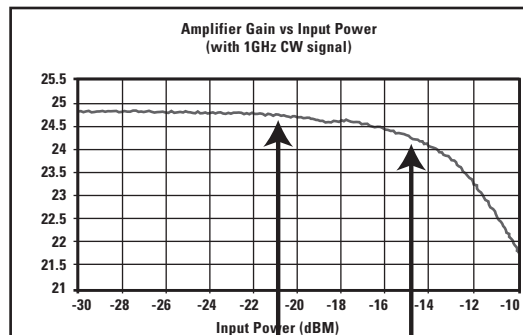
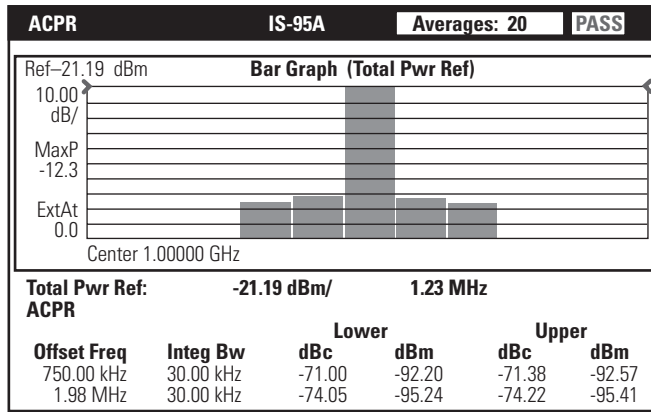

Figure 19: Correlation of amplifier gain and input signal CCDF curve.

will spend at least 3% of the time compressed by 0.6 dB or more. By viewing these curves, an amplifier designer can easily check the amplifier power performances against the desired specifications.

As seen from the CCDF curve comparisons, the output signal has significantly distorted peak-power events. This distortion will affect the Bit Error Rate (BER) or Frame Error Rate (FER) of the system. Therefore, the CCDF curve can be a good tool for determining the optimum signal level for a particular amplifier.

**(a) Amplifier input signal**



**Compression affects other key measurements**

The result of this compression will also affect key amplifier and transmitter system specifications such as Adjacent Channel Power Ratio (ACPR) and code-domain power (CDP). *Figure 20* shows two ACPR measurements comparing the input and output signals of an amplifier. The compression has caused approximately 15 dB degradation in the ACPR of the signal.

**(b) Amplifier output signal**

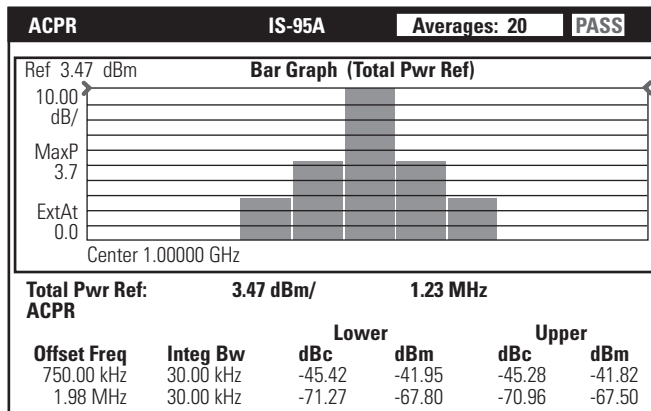
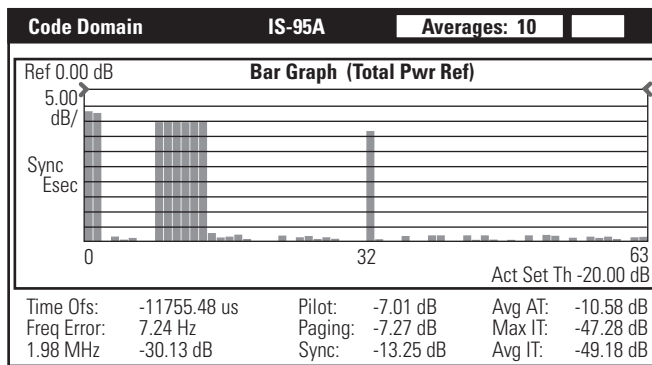

*Figure 21* (page 20) shows the CDP plots of the input and output signal of the amplifier. The amplified signal (with compression) has significantly reduced the Signal-to-Noise Ratio (SNR) of the active channels versus the inactive channels.

Measurements such as ACPR and CDP are well complemented by CCDF curves. While ACPR and CDP give us information regarding overall average power and individual channel power, CCDF tells us the more detailed information about the peaks of a signal.

Figure 20: ACPR increases as the signal passes through the amplifier.

**(a) Amplifier input signal**



**(b) Amplifier output signal**

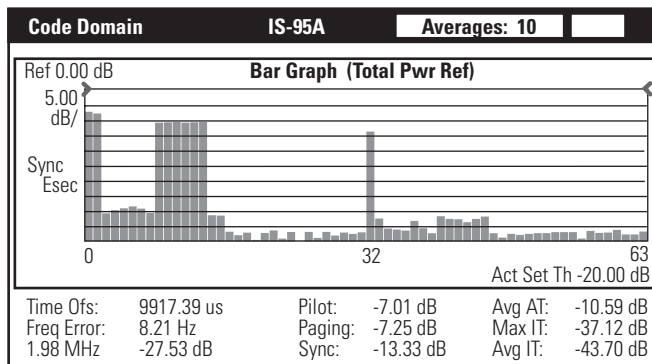

Figure 21: CDP increases as the signal passes through the amplifier.

**Applications**

CCDF curves can help to confirm whether or not a component design performs as specified. For example, a power amplifier designer can compare the CCDF curve of a signal at the input and output of an RF amplifier. If the design is correct, the curves will coincide. However, if the amplifier compresses the signal, the peak-to-average ratio of the signal is lower at the output of the amplifier, which means the CCDF curve decreases. The amplifier designer would need to increase the range of the amplifier to account for the power peaks, or the system designers could lower the average power of the signal to meet the power limitations of the amplifier.

Similarly, CCDF curves can also be used to troubleshoot a system or subsystem design. Making CCDF measurements at several points in the system allows system engineers to verify performance of individual subsystems and components; also, circuit components or subsystems can be tested for linearity non-intrusively.

## Summary

CCDF measurements are becoming a valuable tool in the communications industry. The need for CCDF arises primarily when dealing with digitally modulated signals in spread-spectrum systems such as cdmaOne, cdma2000, and W-CDMA. Because these types of signals are noise-like, CCDF curves provide a useful characterization of the signal power peaks. CCDF is a statistical method that shows the amount of time the signal spends above any given power level. The mathematical origins of CCDF curves are the familiar PDF and CDF curves that most engineering students have seen in an introductory probability and statistics course.

The CCDF measurement is an excellent way to fully characterize the power statistics of a digitally modulated signal. Modulation formats can be compared via CCDF in terms of how stressful a signal is on a component such as an amplifier. The CCDF curve can also be used to determine the impact of filtering on a signal. From the CCDF curves of multi-tone signals, amplifier designers know exactly how much headroom to allow for the peak power excursions to avoid compression. Offsetting the phases of a multi-tone signal can minimize unwanted power peaks. CCDF curves are a powerful way to view and to characterize how various factors affect the peak amplitude excursions of a digitally modulated signal.

In particular, CCDF curves are a valuable measurement tool for spread-spectrum systems. For instance, the number of active codes in a CDMA signal significantly affects the power statistics. Furthermore, different combinations of active codes yield different power CCDF curves, due to orthogonal coding effects. Multi-carrier signals also cause a significant change in CCDF curves, similar to the effect of multi-tone signals. CCDF is becoming a necessary design and testing tool in 3G communications systems.

Perhaps the most important contribution of CCDF curves is in setting the signal power specifications for mixers, filters, amplifiers, and other components. The CCDF measurement can help determine the optimum operation point for components. As this new tool becomes more prevalent, we can expect to see correlation studies between CCDF curve degradation and digital radio system parameters such as BER, FER, CDP, and ACPR.

## References

1. Nick Kuhn, Bob Matrecci, and Peter Thysell,  
*Proper Stimulus Ensures Accurate Tests of CDMA Power*,  
(article reprint) *Microwaves & RF*, January 1998,  
literature number 5966-4786E.
2. *Digital Modulation in Communications Systems*  
– *An Introduction*,  
Application Note 1298,  
literature number 5965-7160E.
3. *Testing and Troubleshooting RF Communications*  
*Transmitter Designs*,  
Application Note 1313,  
literature number 5968-3578E.
4. *Performing cdma2000 Measurements Today*,  
Application Note 1325,  
literature number 5968-5858E.
5. *Understanding CDMA measurements for Base Stations*  
*and Their Components*,  
Application Note 1311,  
literature number 5968-0953E.

## **Symbols and Acronyms**

3G—Third Generation  
8VSB—8-level Vestigial Side Band  
ACPR—Adjacent Channel Power Ratio  
AM—Amplitude Modulation  
AMPS—Advanced Mobile Phone System  
AWGN—Additive White Gaussian Noise  
BER—Bit Error Rate  
CCDF—Complementary Cumulative Distribution Function  
CDF—Cumulative Distribution Function  
CDMA (cdmaOne, cdma2000)—Code Division Multiple Access  
CDP—Code Domain Power  
COFDM—Coded Orthogonal Frequency Division Multiplexing  
CW—Continuous Wave  
dB—Decibel  
dBm—Decibels relative to 1 milliwatt. ( $10\log(\text{power}/1\text{mW})$ )  
DSB-LC—Double-SideBand Large-Carrier  
DSP—Digital Signal Processing  
EDGE—Enhanced Data for GSM Evolution  
FER—Frame Error Rate  
FM—Frequency Modulation  
GSM—Global System for Mobile communications  
HDTV—High Definition TeleVision  
HPSK—Hybrid Phase Shift Keying  
I and Q—In-phase and Quadrature  
NADC—North American Digital Cellular  
NPR—Noise Power Ratio  
OCQPSK—Orthogonal Complex Quadrature Phase Shift Keying  
PDF—Probability Density Function  
QAM—Quadrature Amplitude Modulation  
QPSK—Quadrature Phase Shift Keying  
RF—Radio Frequency  
SNR—Signal to Noise Ratio  
TACS—Total Access Communications System  
VSA—Vector Signal Analyzer  
W-CDMA—Wideband-Code Division Multiple Access

**For more information about Agilent Technologies test and measurement products, applications, services, and for a current sales office listing, visit our web site: <http://www.agilent.com/find/tmdir> You can also contact one of the following centers and ask for a test and measurement sales representative.**

**United States:**

Agilent Technologies  
Test and Measurement Call Center  
P.O. Box 4026  
Englewood, CO 80155-4026  
(tel) 1 800 452 4844

**Canada:**

Agilent Technologies Canada Inc.  
5150 Spectrum Way  
Mississauga, Ontario, L4W 5G1  
(tel) 1 877 894 4414

**Europe:**

Agilent Technologies  
European Marketing Organization  
P.O. Box 999  
1180 AZ Amstelveen  
The Netherlands  
(tel) (31 20) 547 9999

**Japan:**

Agilent Technologies Japan Ltd.  
Measurement Assistance Center  
9-1, Takakura-Cho, Hachioji-Shi,  
Tokyo 192-8510, Japan  
(tel) (81) 426 56 7832  
(fax) (81) 426 56 7840

**Latin America:**

Agilent Technologies  
Latin American Region Headquarters  
5200 Blue Lagoon Drive, Suite #950  
Miami, Florida 33126, U.S.A.  
(tel) (305) 267 4245  
(fax) (305) 267 4286

**Australia/New Zealand:**

Agilent Technologies Australia Pty Ltd  
347 Burwood Highway  
Forest Hill, Victoria 3131  
(tel) 1-800 629 485 (Australia)  
(fax) (61 3) 9272 0749  
(tel) 0 800 738 378 (New Zealand)  
(fax) (64 4) 802 6881

**Asia Pacific:**

Agilent Technologies  
24/F, Cityplaza One, 1111 King's Road,  
Taikoo Shing, Hong Kong  
(tel) (852) 3197 7777  
(fax) (852) 2506 9284

**Technical data is subject to change**

**Copyright © 2000**

**Agilent Technologies**

**Printed in U.S.A. 1/00**

**5968-6875E**



**Agilent Technologies**

Innovating the HP Way